

Citroen Dispatch | 2016on | L3H1 (LWB) | Panel Van
Peugeot Expert | 2016on | L3H1 (LWB) | Panel Van
Toyota Proace | 2016on | L3H1 (LWB) | Panel Van
Vauxhall Vivaro | 2019on | L2H1 (LWB) | Panel Van

Raised Floor No.2B

SKU: EPD_16_L2-3_FF2B

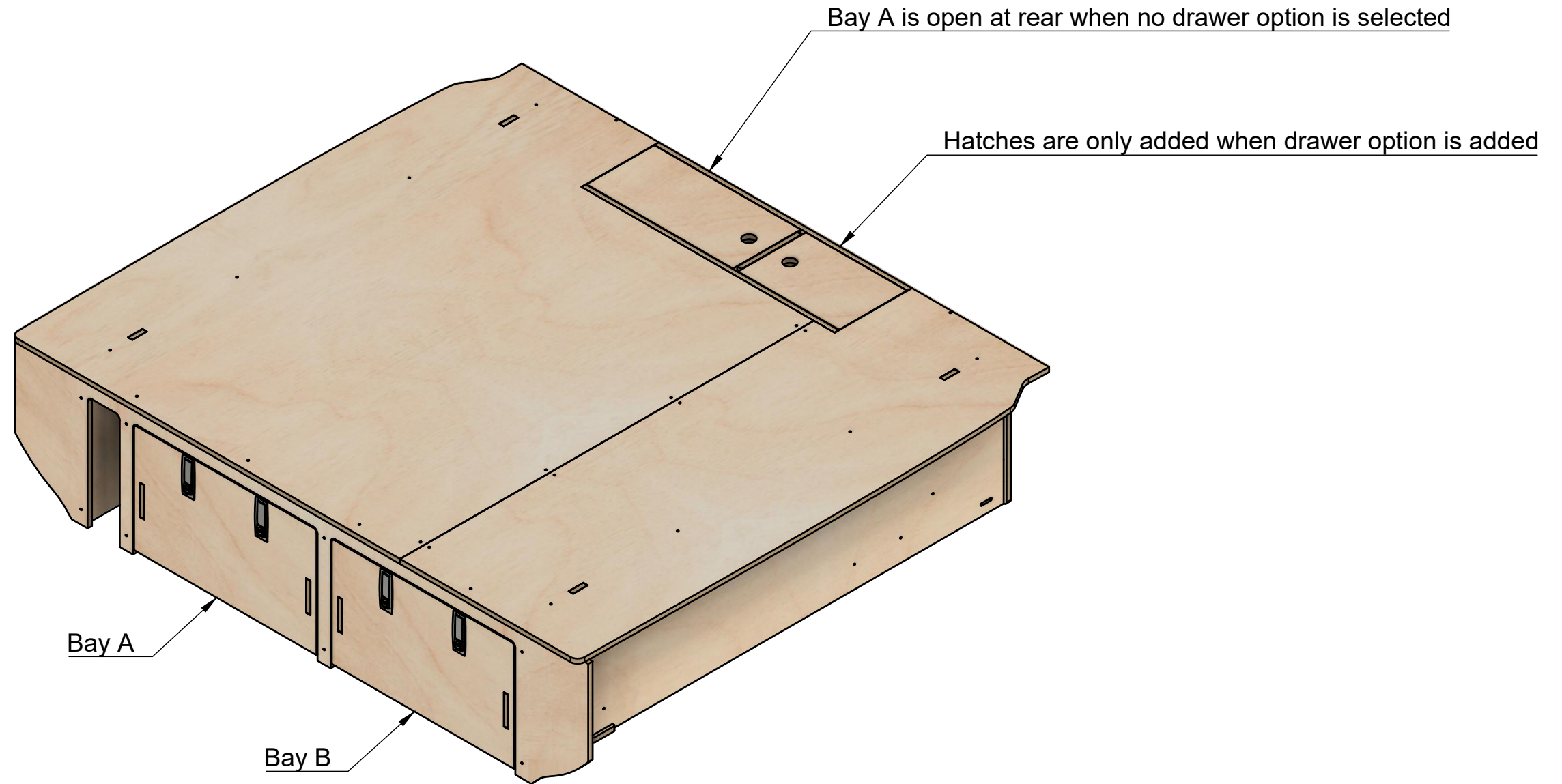

Page 1 - Floor Only

All units in mm
Plywood thickness = 12mm

YOKE VANS
info@yoke-van-kits.co.uk
0208 132 9221

© 2023 Yoke CNC LTD

Citroen Dispatch | 2016on | L3H1 (LWB) | Panel Van
Peugeot Expert | 2016on | L3H1 (LWB) | Panel Van
Toyota Proace | 2016on | L3H1 (LWB) | Panel Van
Vauxhall Vivaro | 2019on | L2H1 (LWB) | Panel Van

Raised Floor No.2B

SKU: EPD_16_L2-3_FF2B

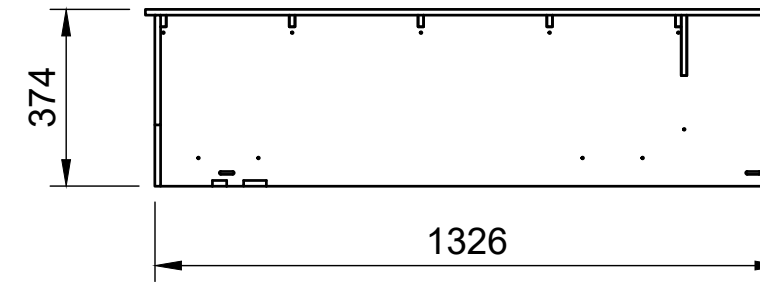
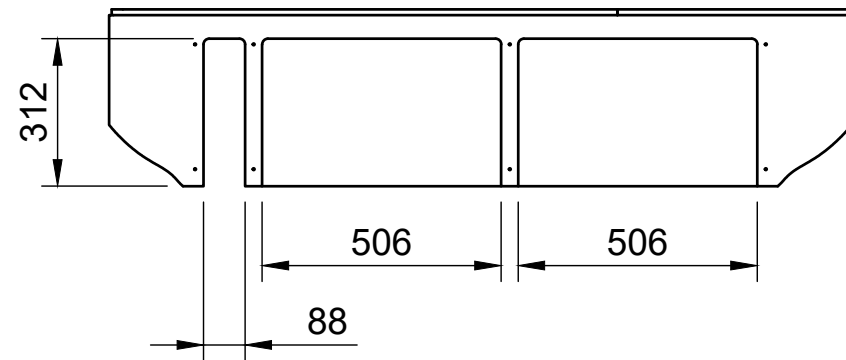
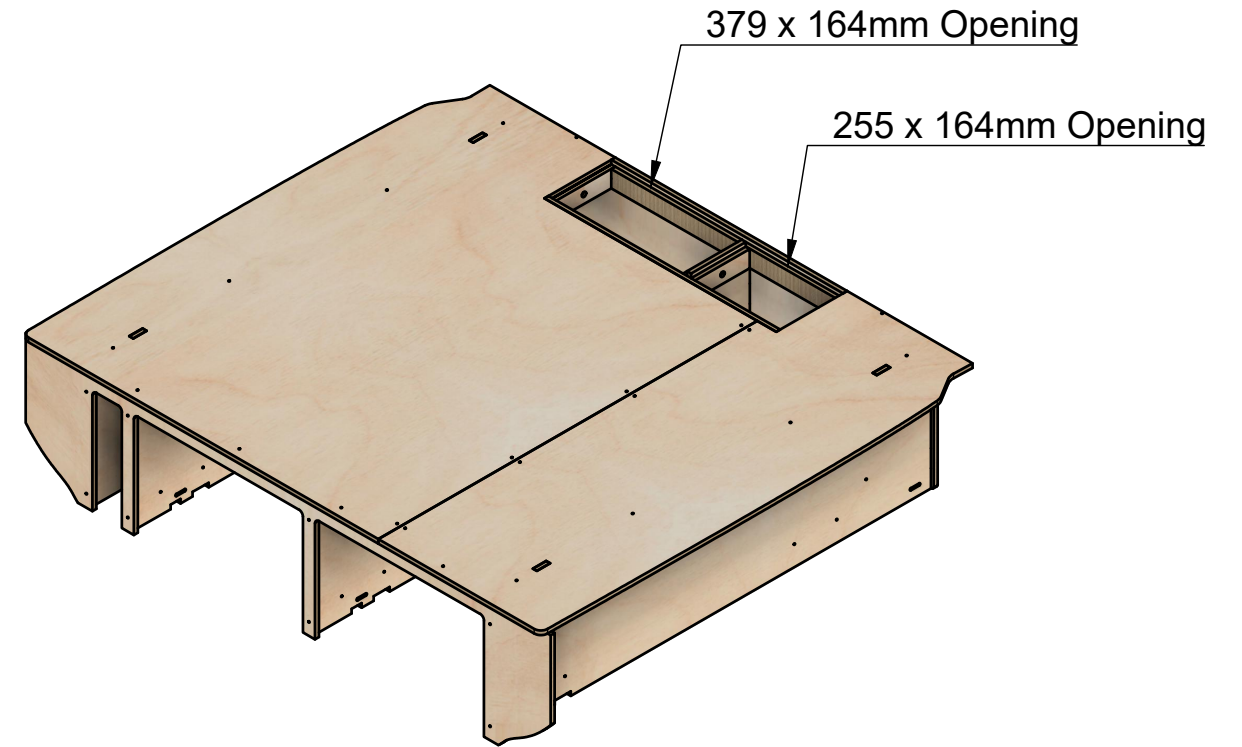

Page 2 - Floor Dimensions

All units in mm
Plywood thickness = 12mm

YOKE VANS
info@yoke-van-kits.co.uk
0208 132 9221

© 2023 Yoke CNC LTD

Citroen Dispatch | 2016on | L3H1 (LWB) | Panel Van
Peugeot Expert | 2016on | L3H1 (LWB) | Panel Van
Toyota Proace | 2016on | L3H1 (LWB) | Panel Van
Vauxhall Vivaro | 2019on | L2H1 (LWB) | Panel Van

Raised Floor No.2B

SKU: EPD_16_L2-3_FF2B

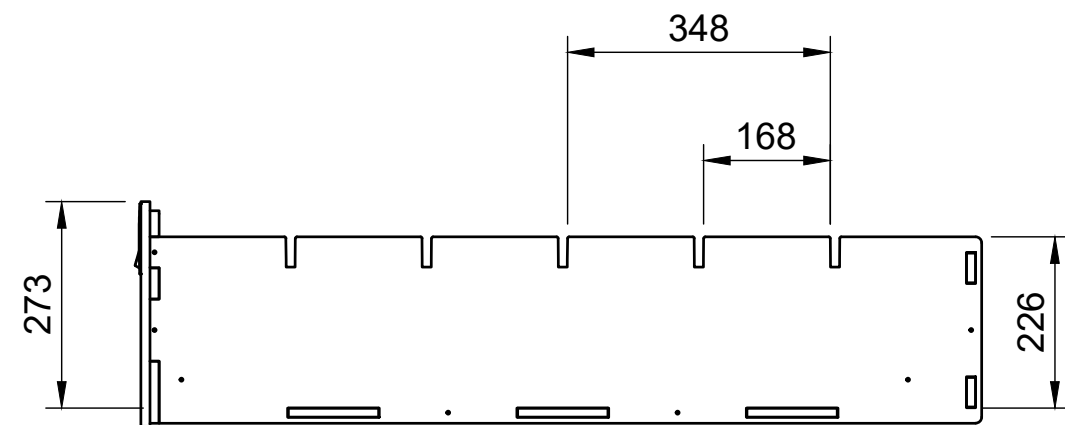
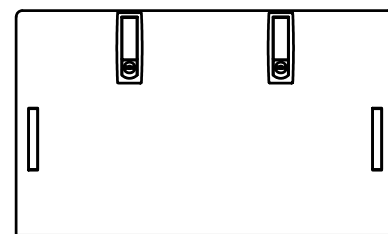
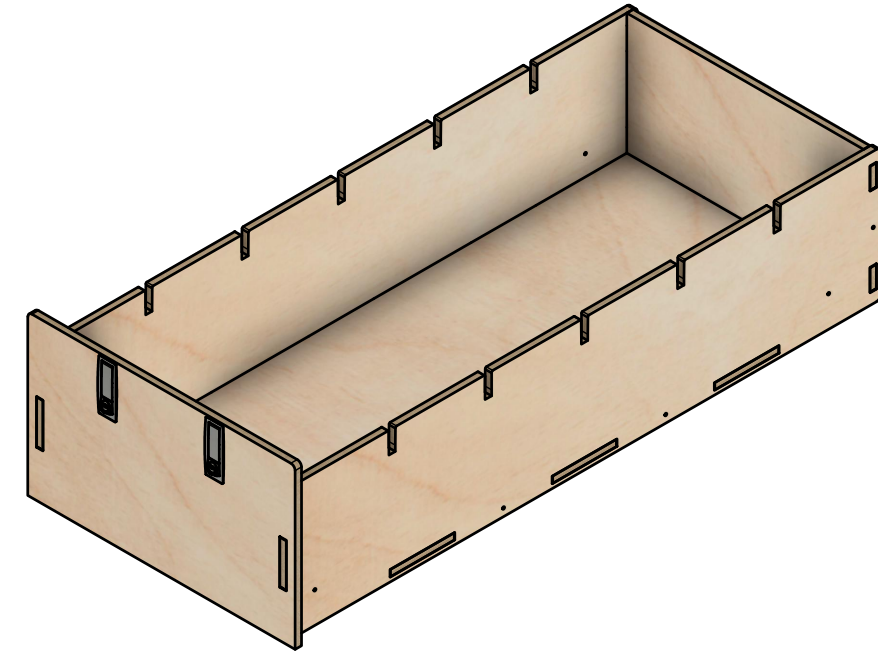
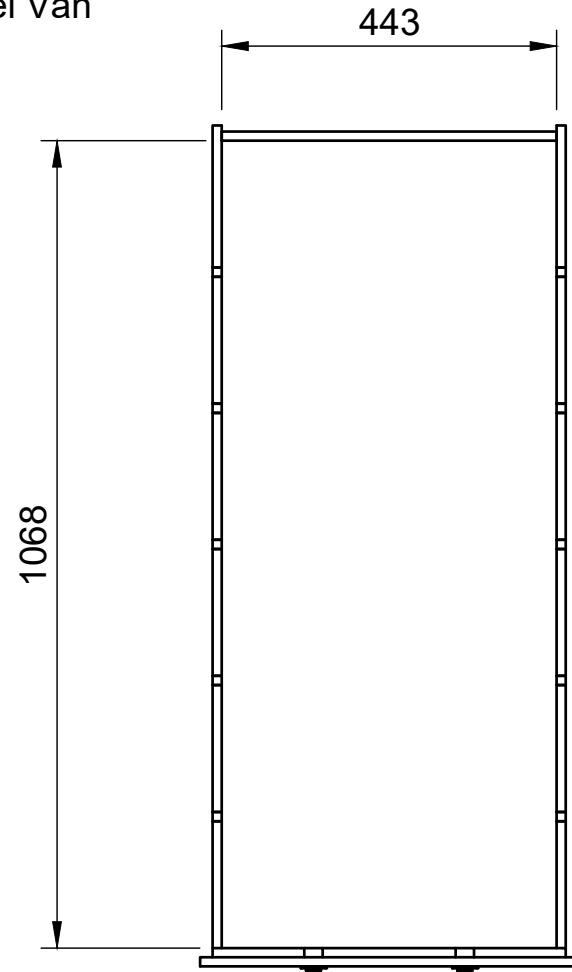

Page 3 - Bay A Drawer Dimensions

All units in mm
Plywood thickness = 12mm

YOKE VANS
info@yoke-van-kits.co.uk
0208 132 9221

© 2023 Yoke CNC LTD

Citroen Dispatch | 2016on | L3H1 (LWB) | Panel Van
Peugeot Expert | 2016on | L3H1 (LWB) | Panel Van
Toyota Proace | 2016on | L3H1 (LWB) | Panel Van
Vauxhall Vivaro | 2019on | L2H1 (LWB) | Panel Van

Raised Floor No.2B

SKU: EPD_16_L2-3_FF2B

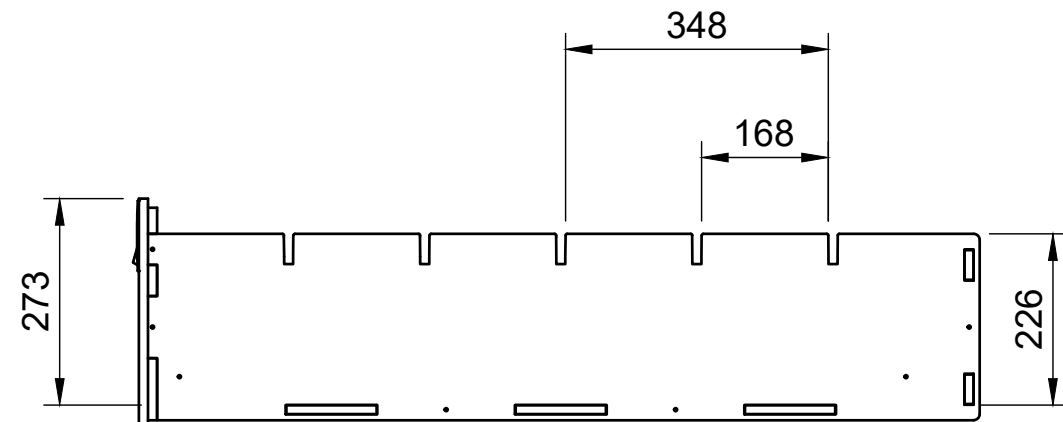
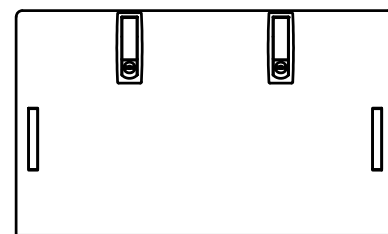
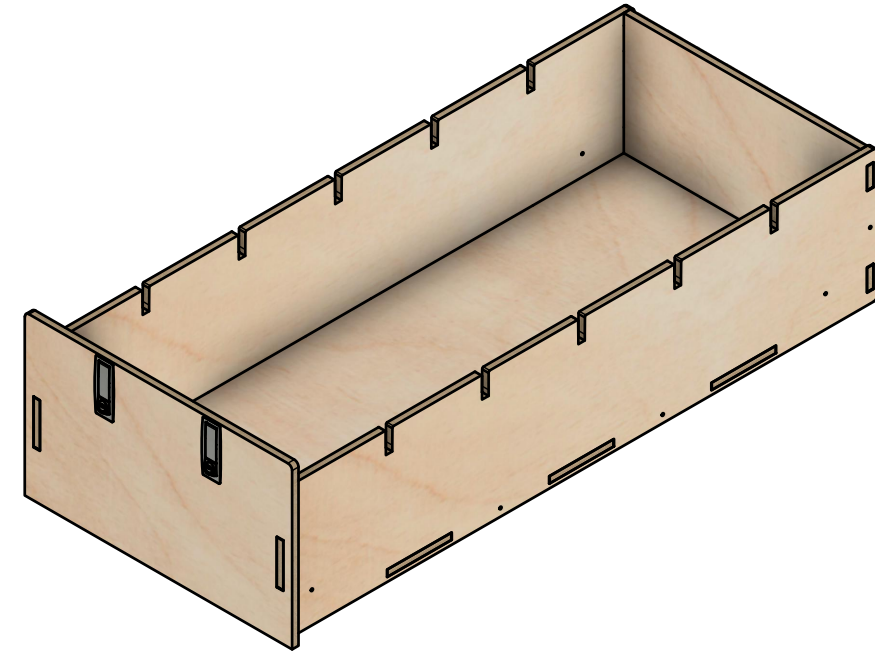
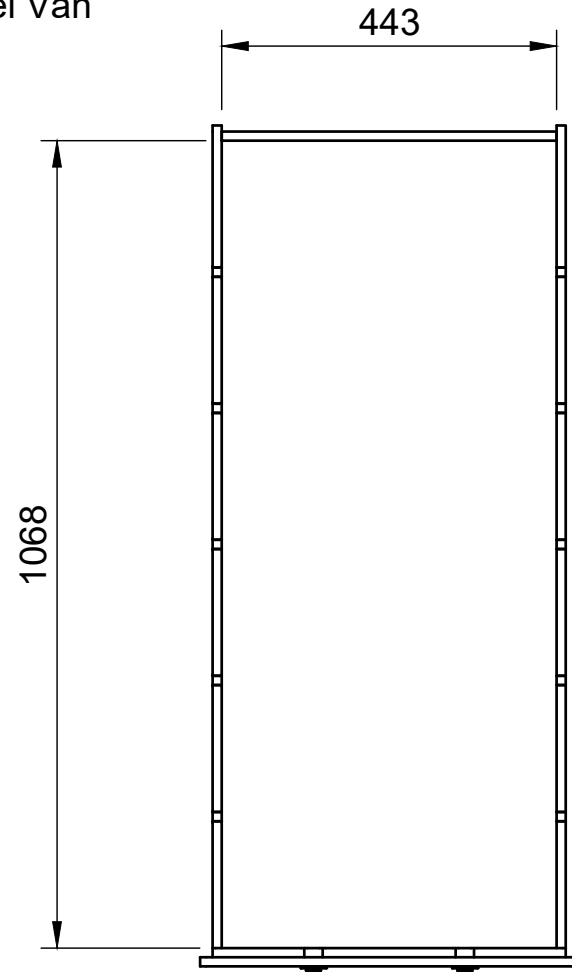

Page 4 - Bay B Drawer Dimensions

All units in mm
Plywood thickness = 12mm

YOKE VANS
info@yoke-van-kits.co.uk
0208 132 9221

© 2023 Yoke CNC LTD